

Electronic CAD

Corso Materiali intelligenti e Biomimetici
02-03/05/2019

ludovica.cacopardo@ing.unipi.it

Design of innovative testing systems

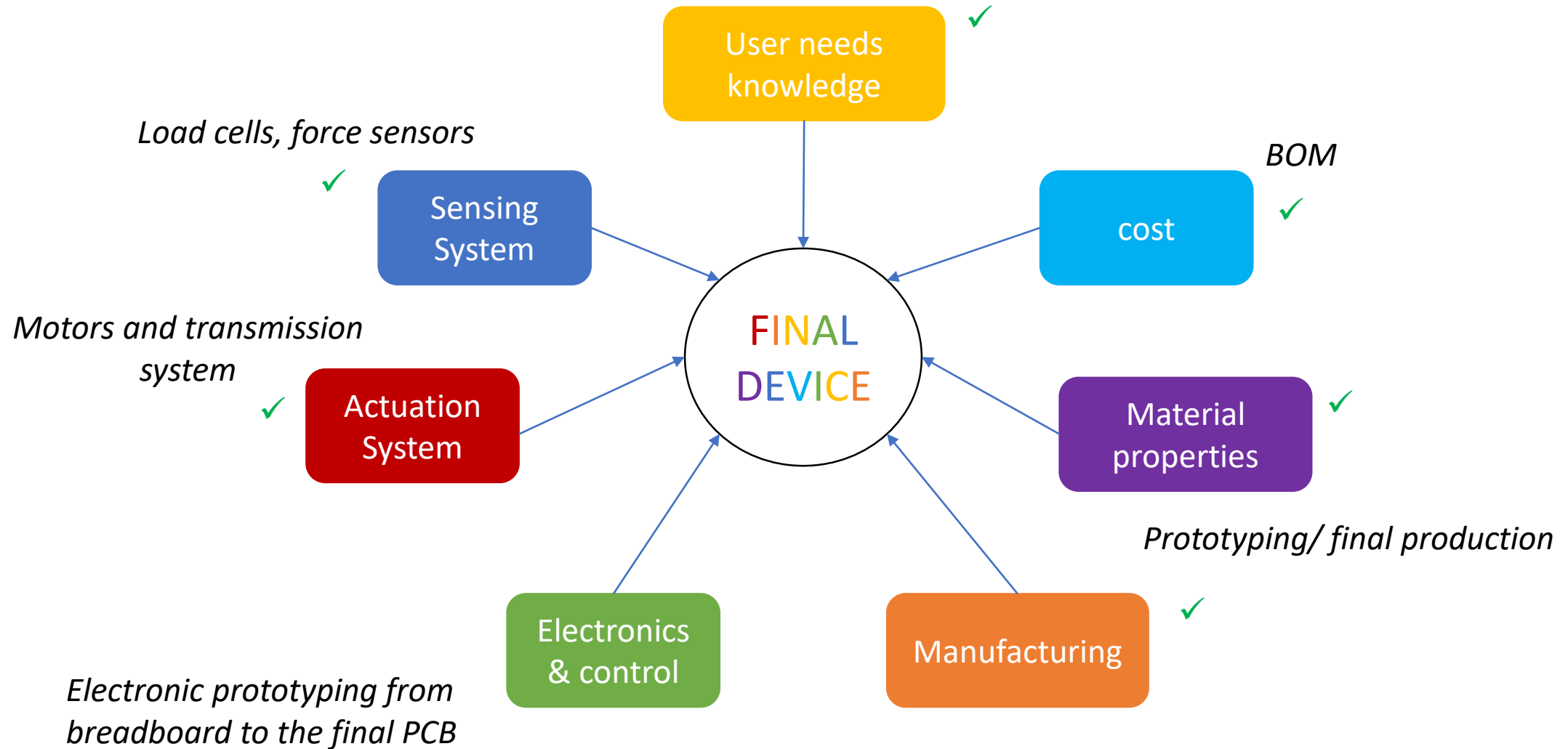

Electronic and electromechanical prototyping

If you wanted to build a circuit prior to the 1960s, chances are you would have used a technique called **wire-wrap**.

Wire wrap is a process that involves wrapping wires around conductive posts attached to a **perfboard**. As you can see, the process can get rather complex very quickly. Although this method is still used today, there is something that makes prototyping much easier, **breadboards**!

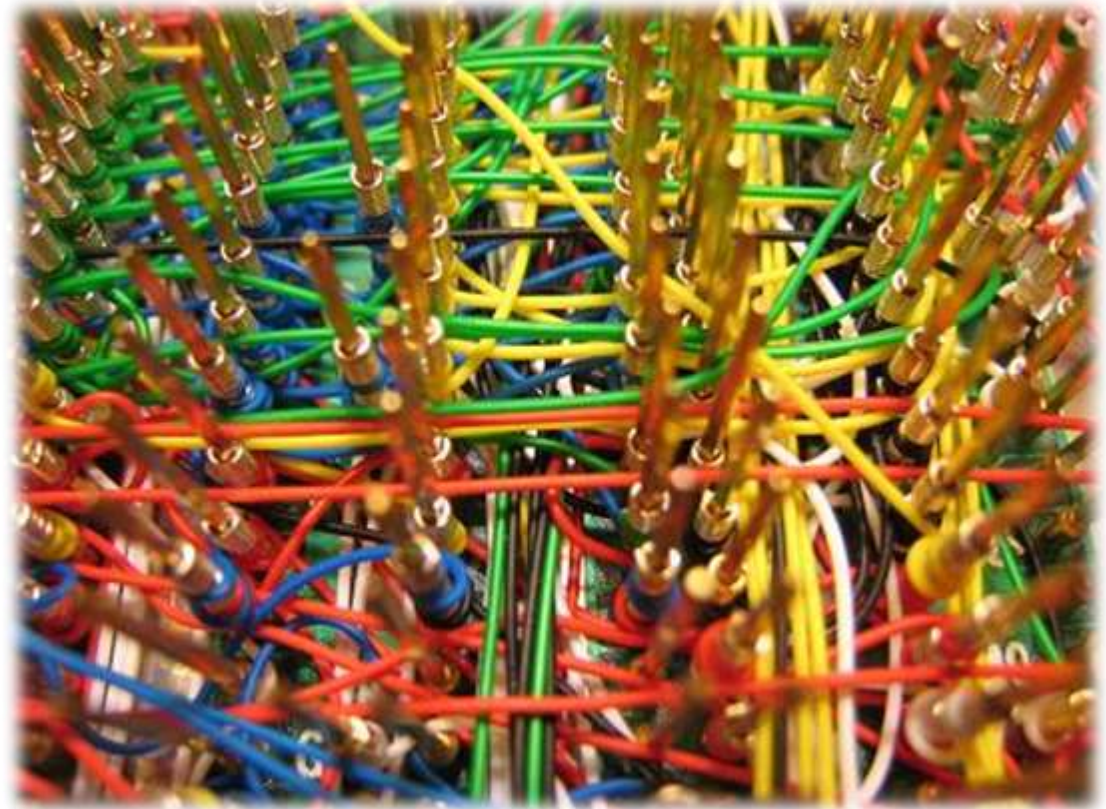

Breadboards

An electronics breadboard is actually referring to a **solderless breadboard**. These are great units for making temporary circuits and prototyping, and they require absolutely no soldering.

Another common use of breadboards is testing out new parts, such as Integrated circuits (ICs). When you are trying to figure out how a part works and constantly rewiring things, you don't want to have to solder your connections each time.

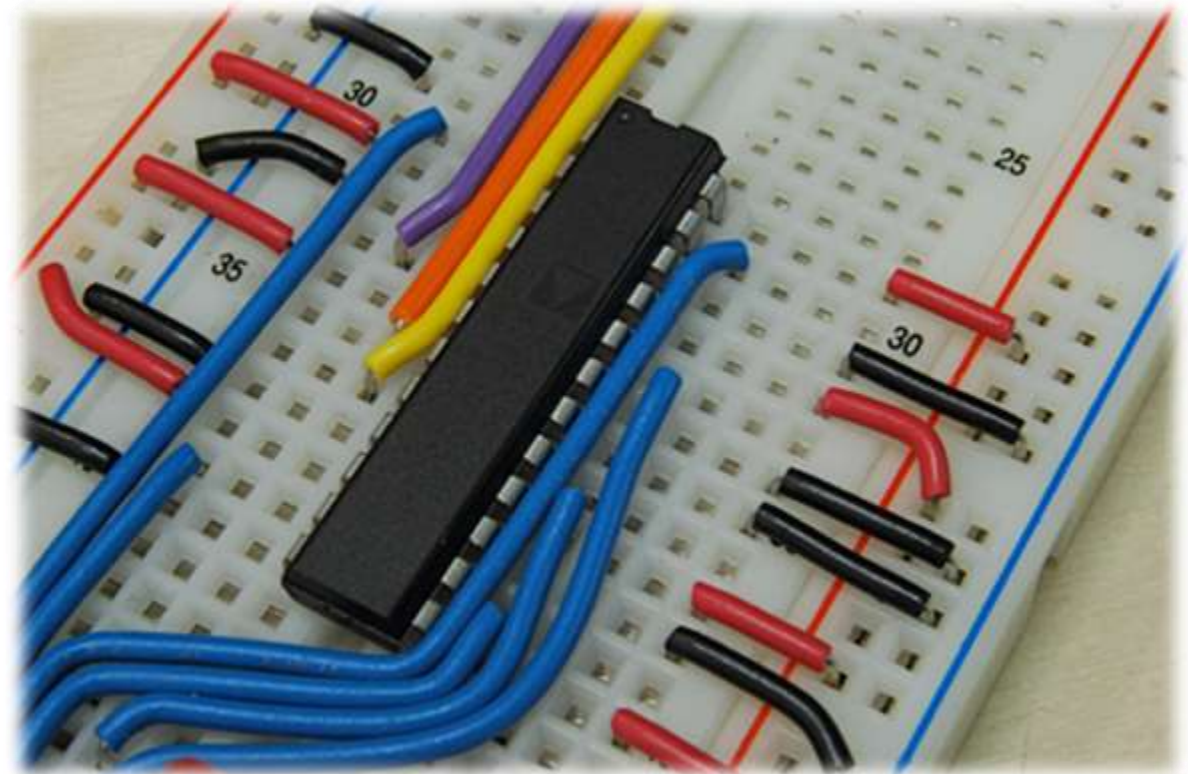

Breadboards 2

Terminal Strips are horizontal rows of metal strips on the bottom of the breadboard. *Once inserted that component will be **electrically connected** to anything else placed in that row.* This is because the metal rows are conductive and allow current to flow from any point in that strip.

Power Rails are metal strips that run vertically along the sides. When building a circuit, you tend to need power in lots of different places. The power rails give you lots of **easy access to power** wherever you need it in your circuit. Usually they will be labeled with a '+' and a '-', to indicate the positive and negative side. It is important to be aware that the *power rails on either side are not connected*, so if you want the same power source on both sides, you will need to connect the two sides with some jumper wires.

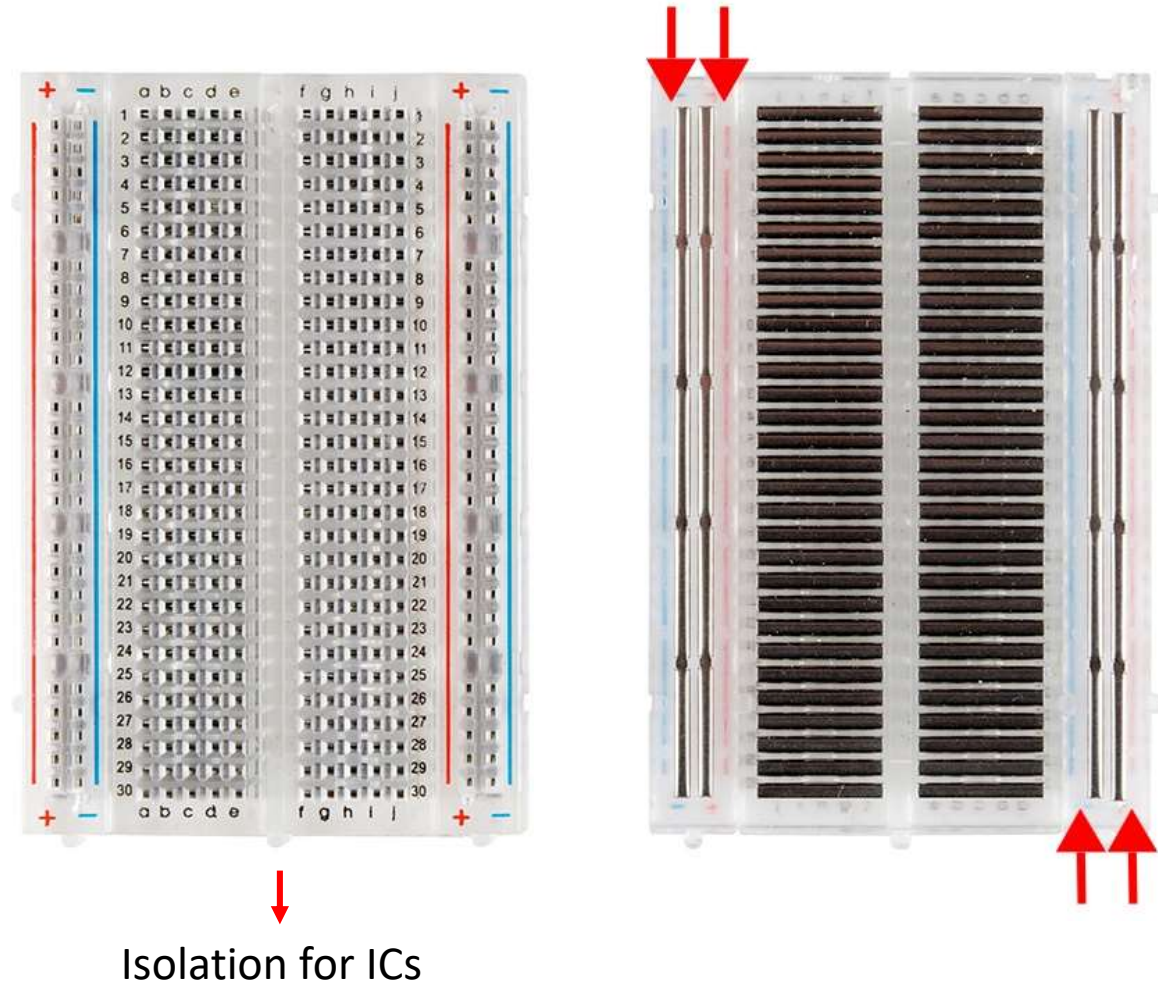

ICs

DIP Support: Many integrated circuits (ICs) or, simply, chips, are manufactured specifically to fit onto breadboards. In order to minimize the amount of space they take up on the breadboard, they come in what is known as a *Dual in-line Package (DIP)*.

These DIP chips have legs that come out of both sides and fit perfectly over the ravine that isolates the two sides of a breadboard. Since each leg on the IC is unique, we don't want both sides to be connected to each other.



PIN CONFIGURATION

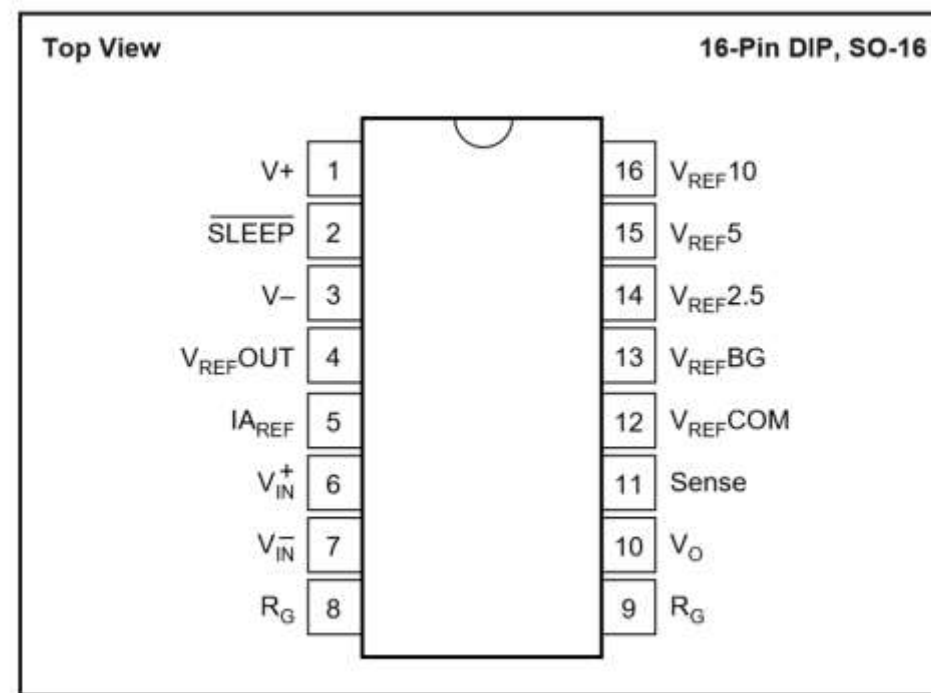

After Breadboards: Matrix Boards

We use breadboards for quick construction, **Matrix Boards** for laying out a project so it can be copied to make a Printed Circuit Board.

This is a prototyping board, with *copper pads in a matrix layout*. You solder the components in place, and then simply cut pieces of wire, and solder them to make the circuit

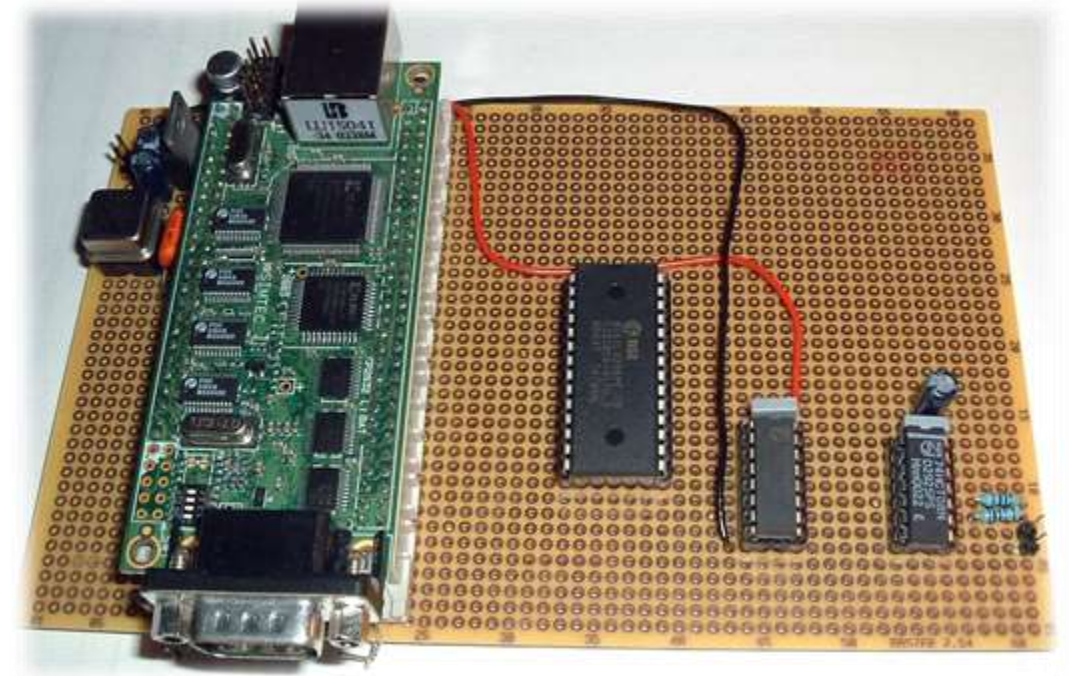

Printed Circuit Board

The PCB is the physical board that holds and connects all of the electronic components.

The circuits are formed by a **thin layer of conducting material deposited**, or "printed," **on the surface of an insulating board known as the substrate**. Individual electronic components are placed on the surface of the substrate and soldered to the interconnecting circuits.

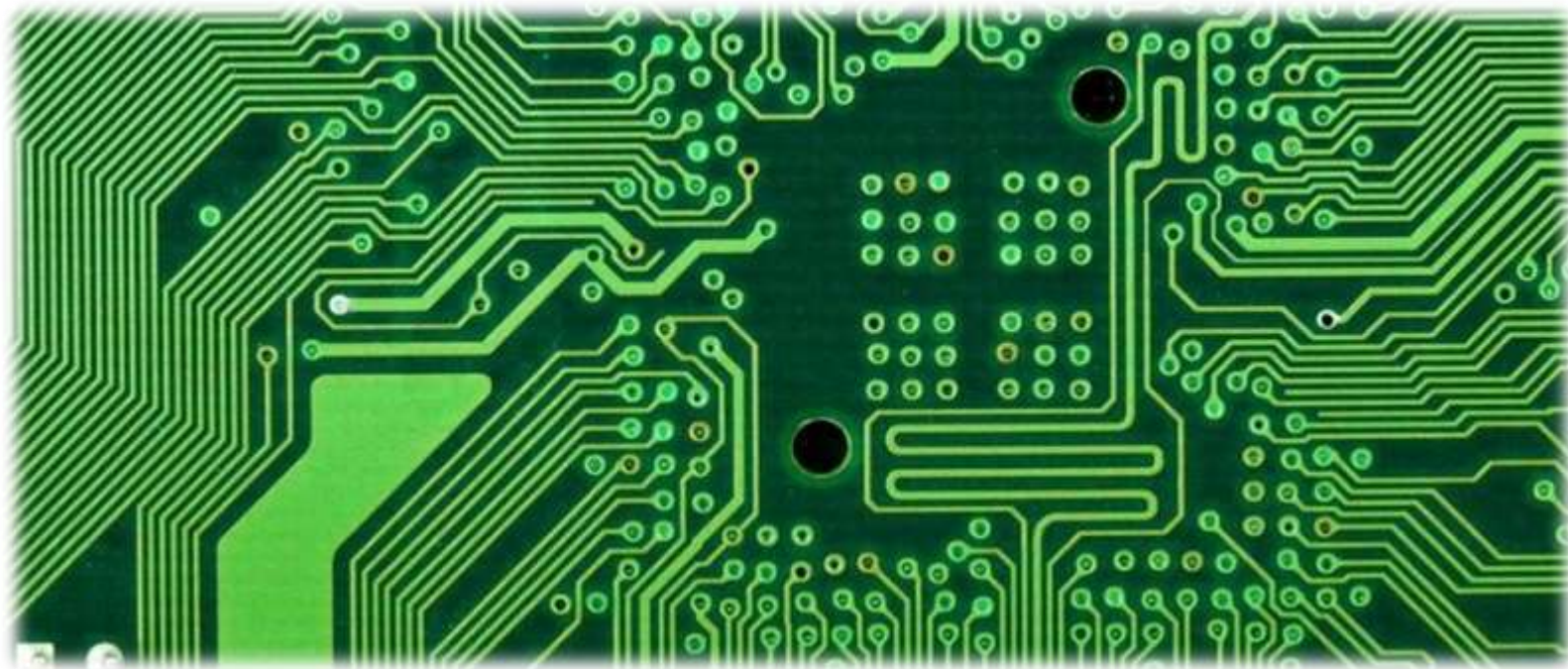

Critical Components Selection

The first step of designing the electronics is to select the various microchips* (i.e. integrated circuits), sensors, displays, connectors, and other electronic devices needed based upon the desired functions and target retail price of your product.

[Digikey](#), RS, and [Mouser](#) are the most popular suppliers of electronic components. You can purchase most electronic components in ones (for prototyping and initial testing) or up to thousands (for low-volume manufacturing)

*Chip Packaging

- DIP (dual in-line package): The package may be through-hole mounted to a PCB or inserted in a socket
- SMD (surface mount device): the components are mounted or placed directly onto the surface of PCBs

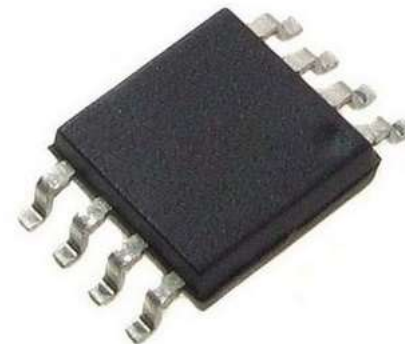
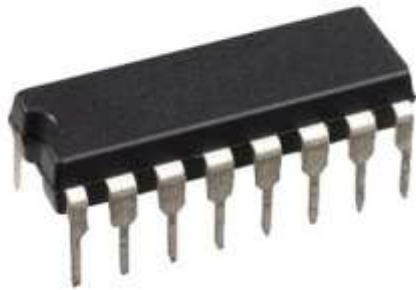

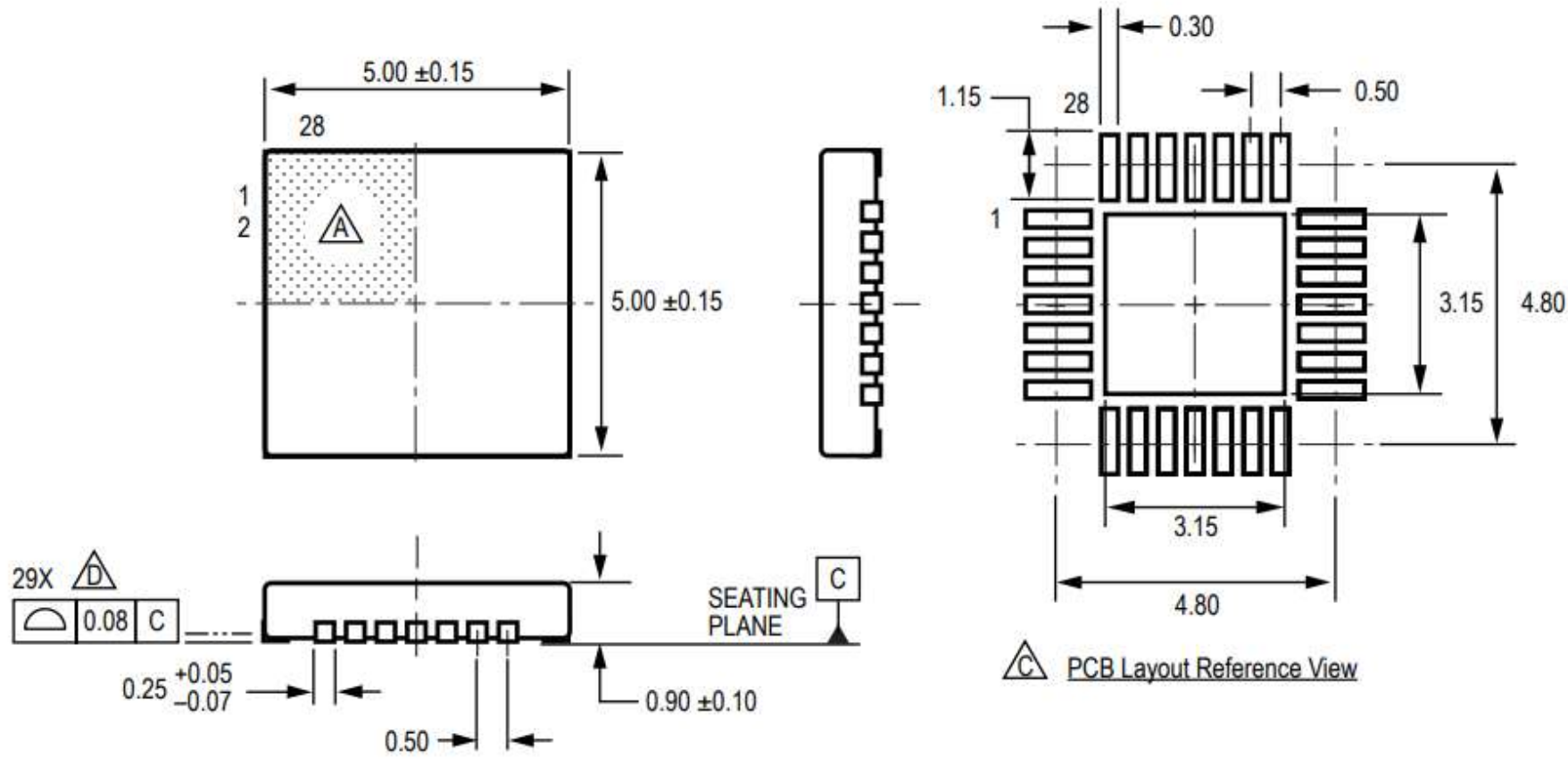

Other Components

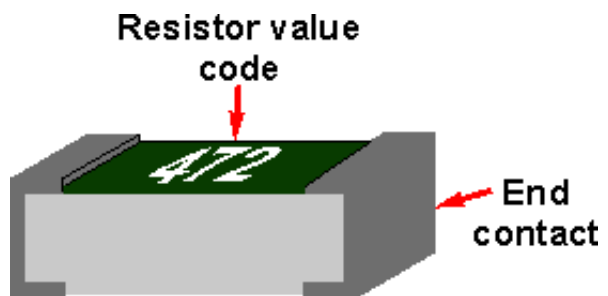

eCAD

Electronic computer-aided design (eCAD) or Electronic design automation (eDA) is a category of **software tools for designing electronic systems** such as integrated circuits and printed circuit boards. The tools work together in a design flow that chip designers use to design and analyze entire semiconductor chips.

Before EDA, integrated circuits were designed by hand and manually laid out.

By the mid-1970s, developers started to automate the design along with the drafting. The first **placement and routing** tools were developed.

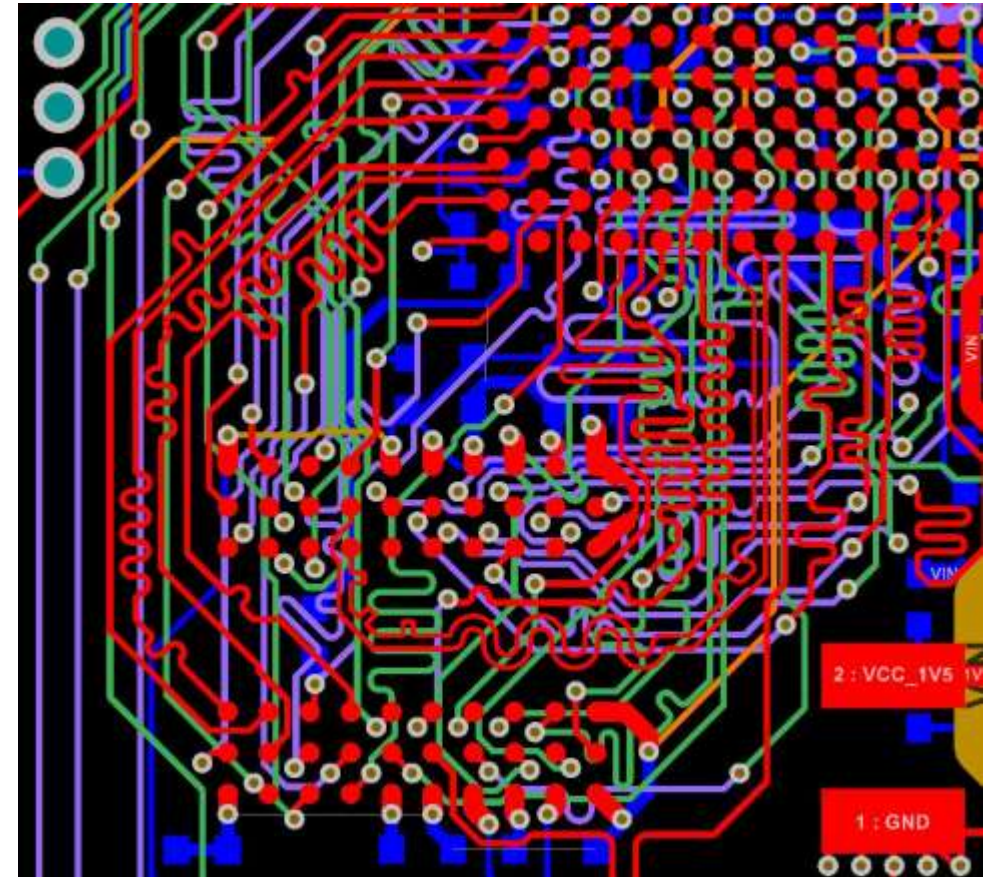

Printed Circuit Board Design

PCB eCAD Software (e.g. Eagle, PCB123):

PCB design in EAGLE is a two-step process. First you design your **schematic**, then you **lay out** a PCB based on that schematic.

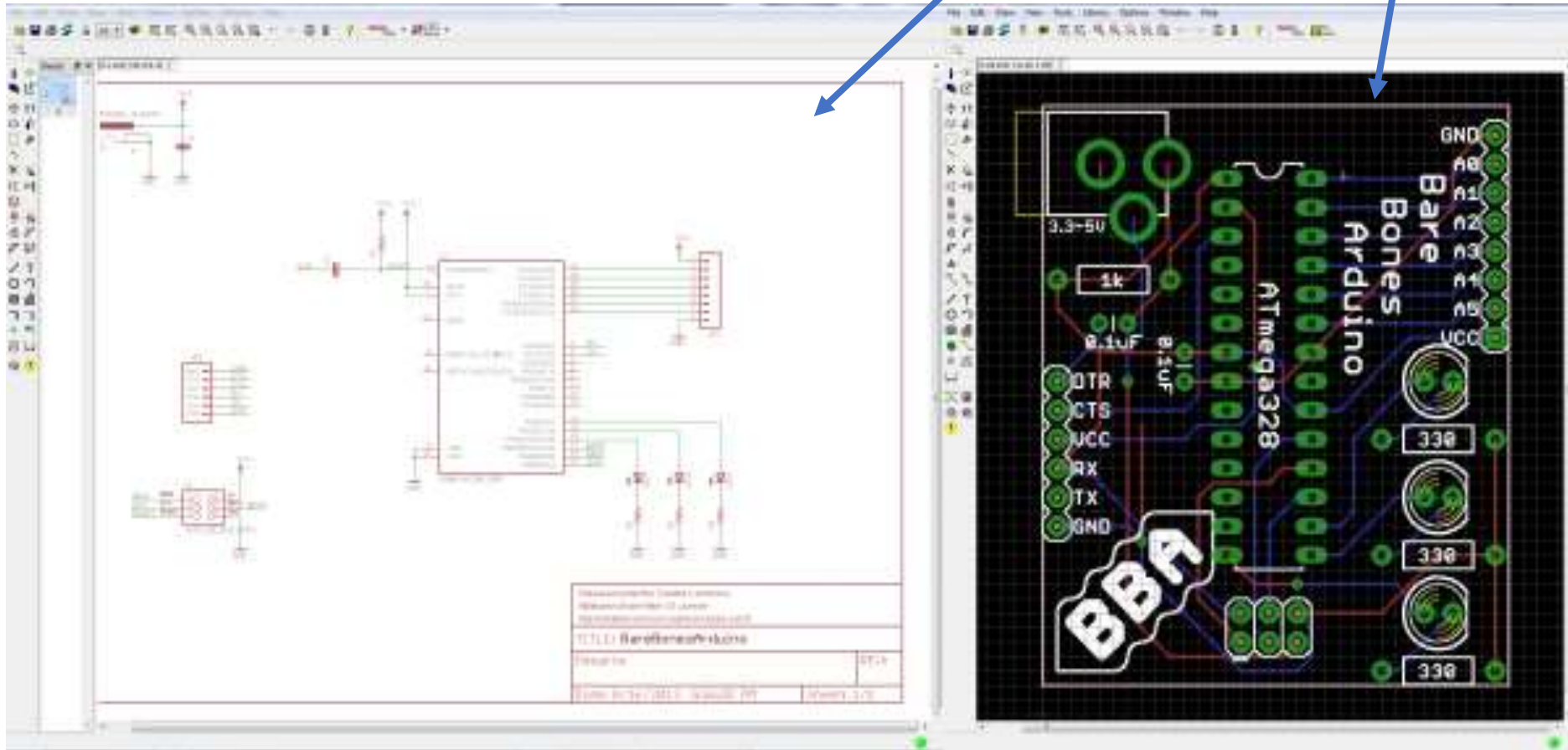

PCB Design (2)

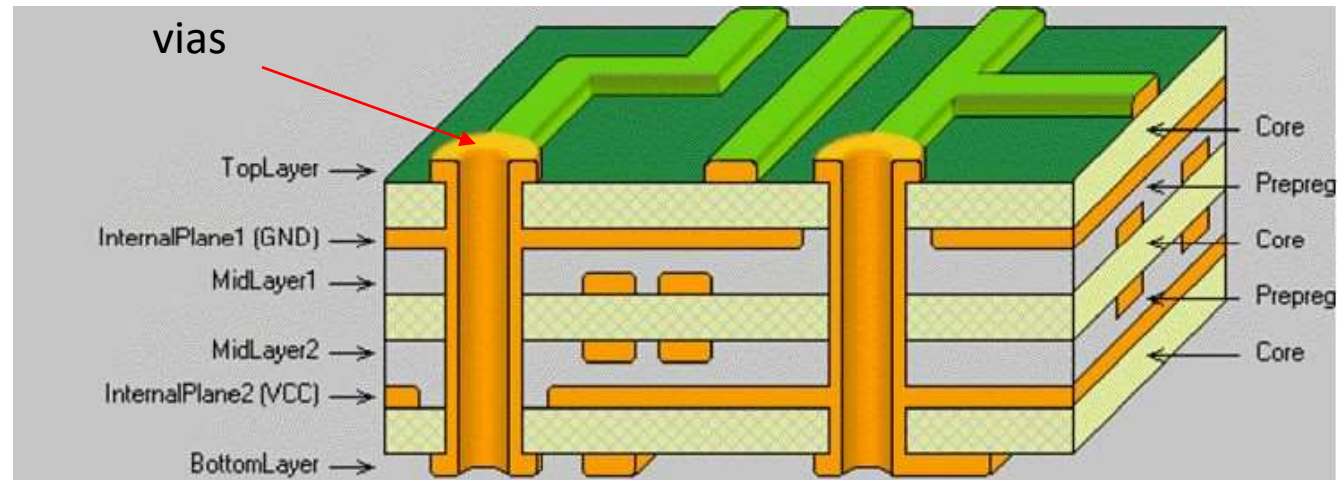

Your *circuit design software* will allow you to output the PCB layout in a format called **Gerber** with one file for each PCB layer (copper layers, solder mask, legend or silk) to allow manufacturing.

During board fabrication Gerber is the standard input format for photoplotters and all other fabrication equipment.

The final step is having all of the electronic **components soldered onto the board**.

The logo for Fritzing, featuring the word "fritzing" in a white, lowercase, sans-serif font with small circles above the 'i' and 'n' characters, set against a red rectangular background.

Fritzing is an open source tool for anyone to prototype electronic projects. It allows you to **design a schematic** which can then be added to **wiring diagrams**. You can even **design your own PCBs** and have them fabricated from the files you design.

There are **three views / design modes** which are the Breadboard, the Schematic, and the PCB mode. You may choose what suits your particular design needs best and start designing. At any time, you can switch between the view modes to check how the changes are reflected.

<http://fritzing.org/home/>

Step 1: Design on Breadboard

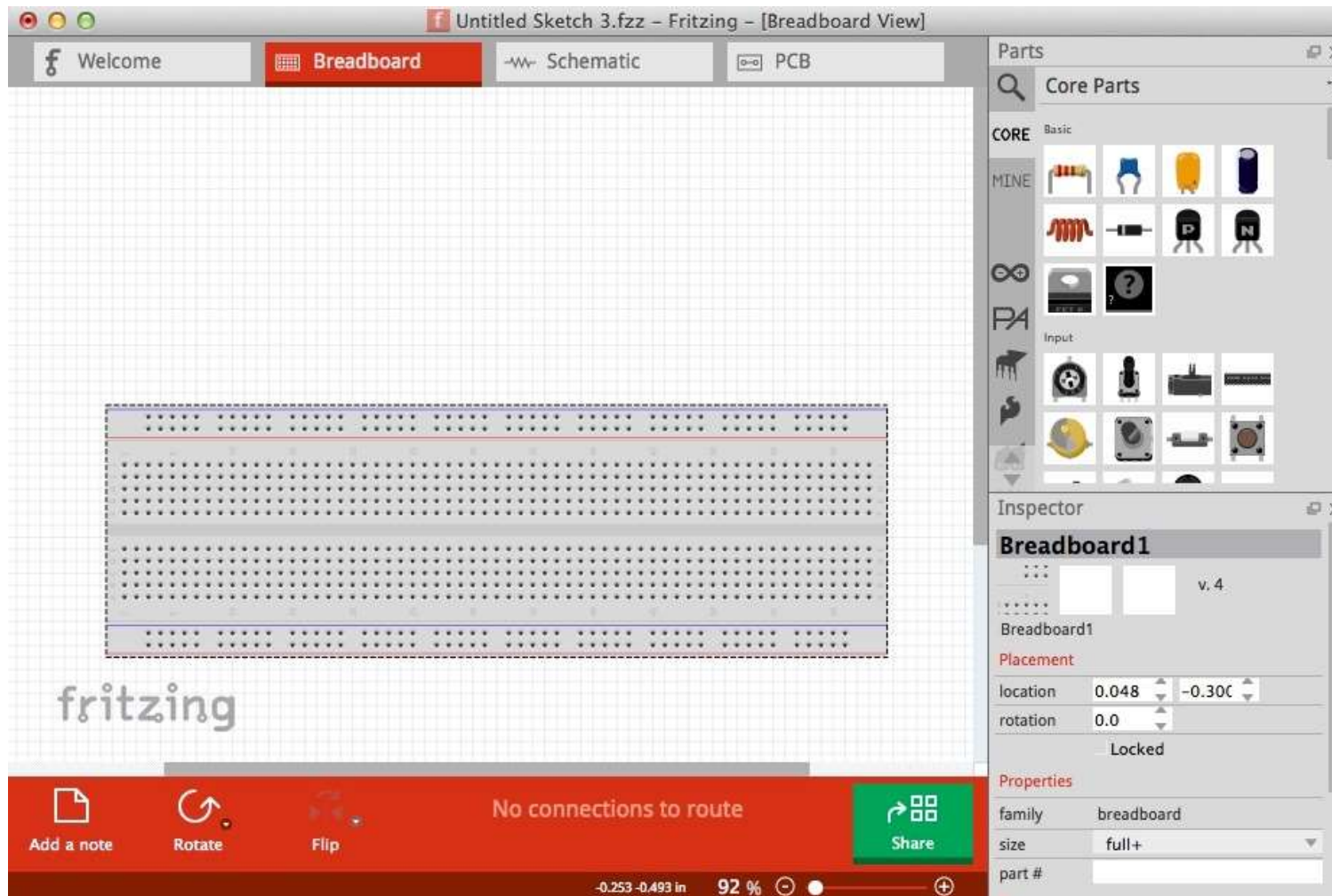

The **parts** are found on the right side and are *categorized based on their type*.

As the part lists are very long, Fritzing also offers a *handy part search engine* that users can invoke by pressing the “magnifier” icon on the right.

Once you find the part you want to use, you may simply drag and drop it on the drawing space in the main window.

Step 2: Schematic view

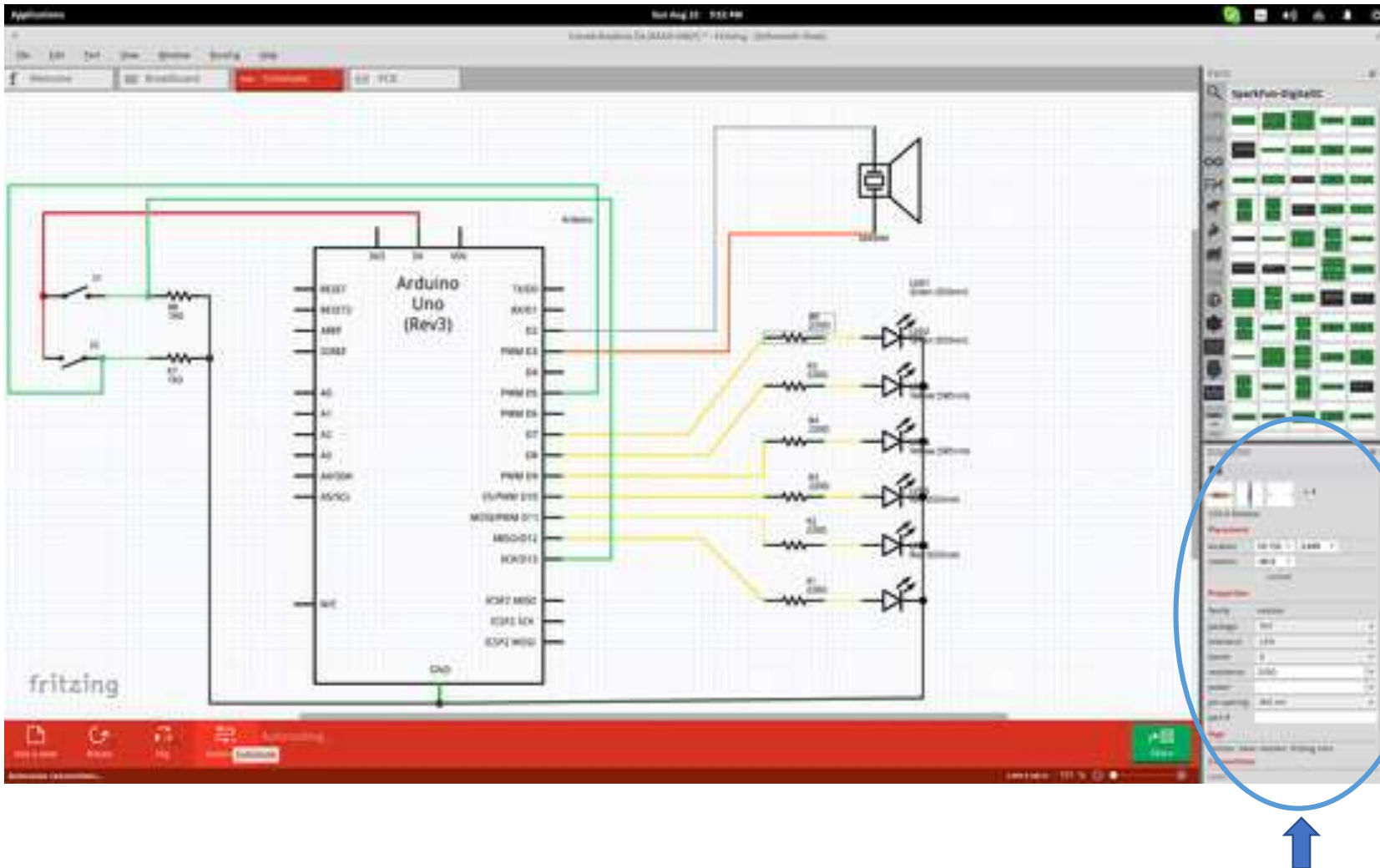

The parts feature **ports** are best shown in the “Schematic” view mode so that the user can comfortably connect what is needed.

Finally, you can change the **technical specifications** of a part by selecting it (after placement) and setting the values from the boxes on the lower right.

Step 3: PCB Layout

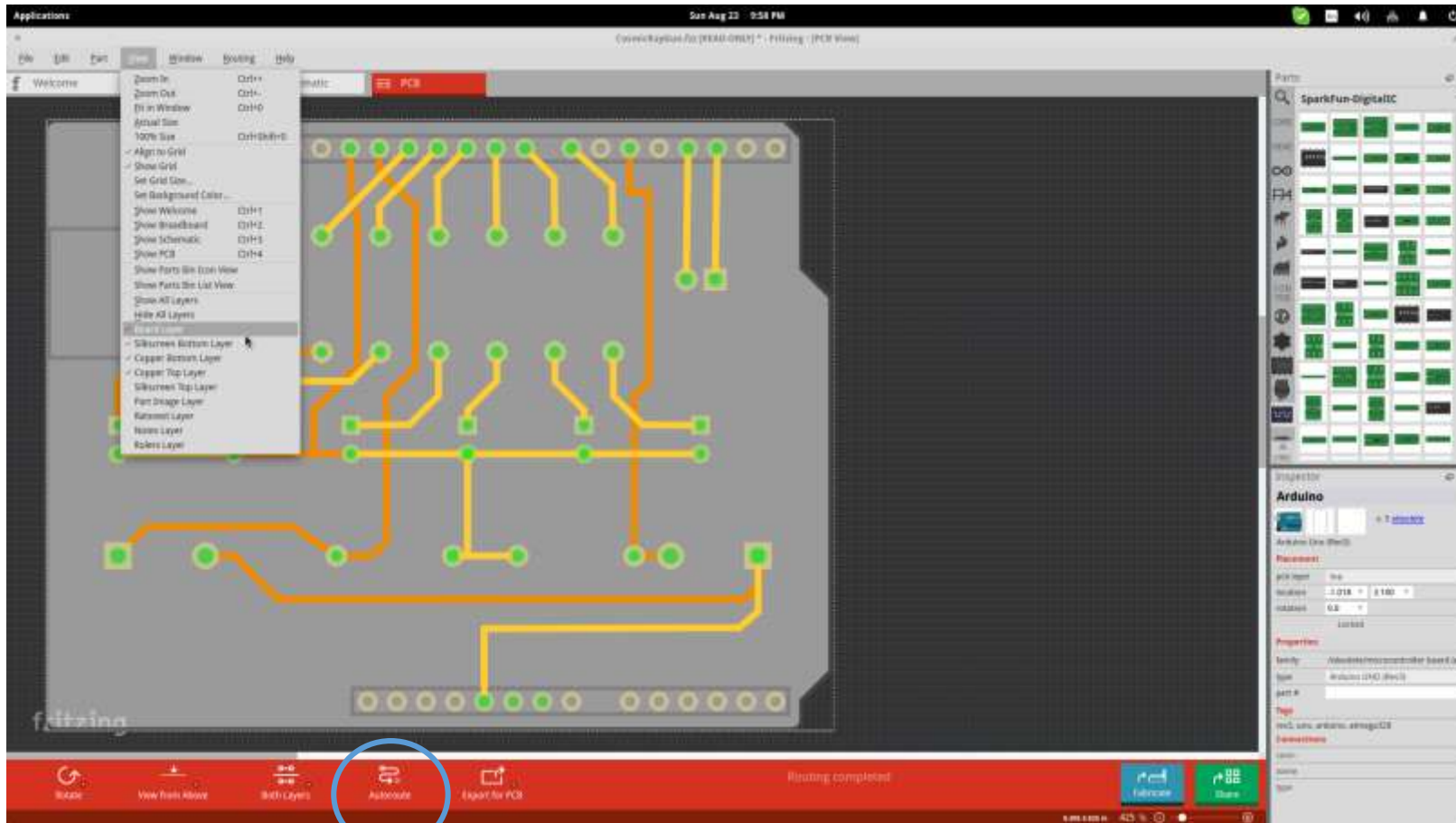

Especially for the PCB, it would be useful to **check it both from above and from below** before finalizing the positions of each part.

Another helpful viewing feature is the **layer selection** that is done from the “View” menu found on the top panel.

There's also an “**auto routing**” option (press Ctrl+Shift+A) that helps users who are unsure about how to wire their boards in the best way.

Routing is the process of laying down tracks to connect components on your board.

1. Keep nets as **short as possible**. The longer your total track length, the greater it's resistance, capacitance and inductance. All of which can be undesirable factors.
2. **Avoid the use of right angles**. This is important to give a professional and neat appearance to your board, and for manufacturing implications.
3. Put everything that as to be in the PCB (i.e. chips, tracks, etc) **inside the physical board**. For the components that are not physically part of the PCB (e.g. motor, sensors, LCD, etc) put only **connectors** (pins, headers).

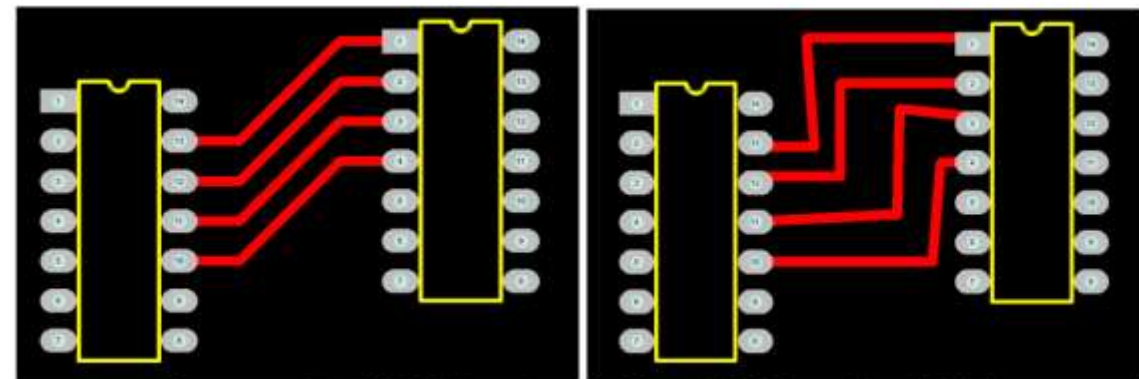
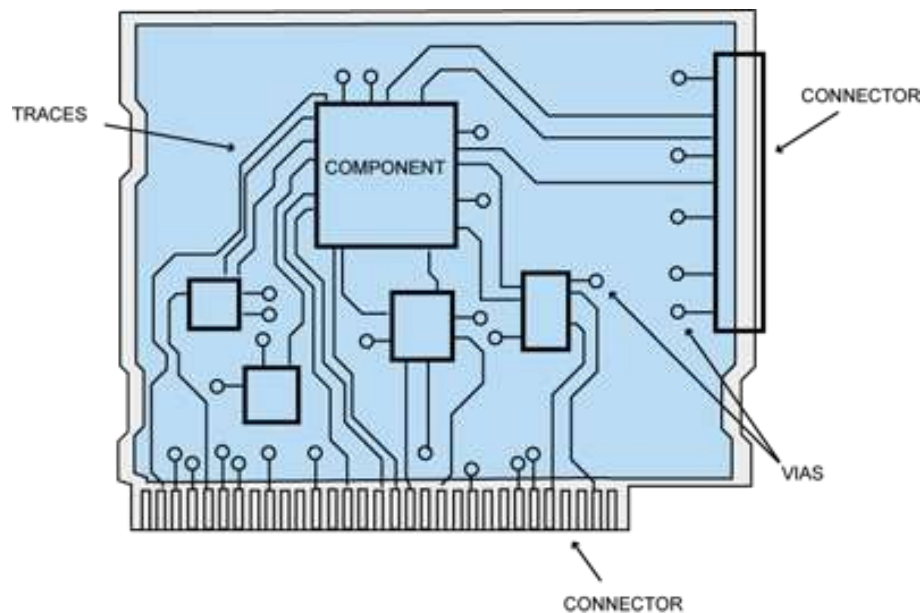

An example of GOOD routing (Left) and BAD routing (Right)

Vias: electrical connection between different layer of the PCB

Exporting a circuit

After finishing building the circuit, save your project. You can export your circuit in different format.

Select the desired Project View to be exported (breadboard, schematic or pcb). From the Fritzing menu bar, select **File > Export >** and the desired format.

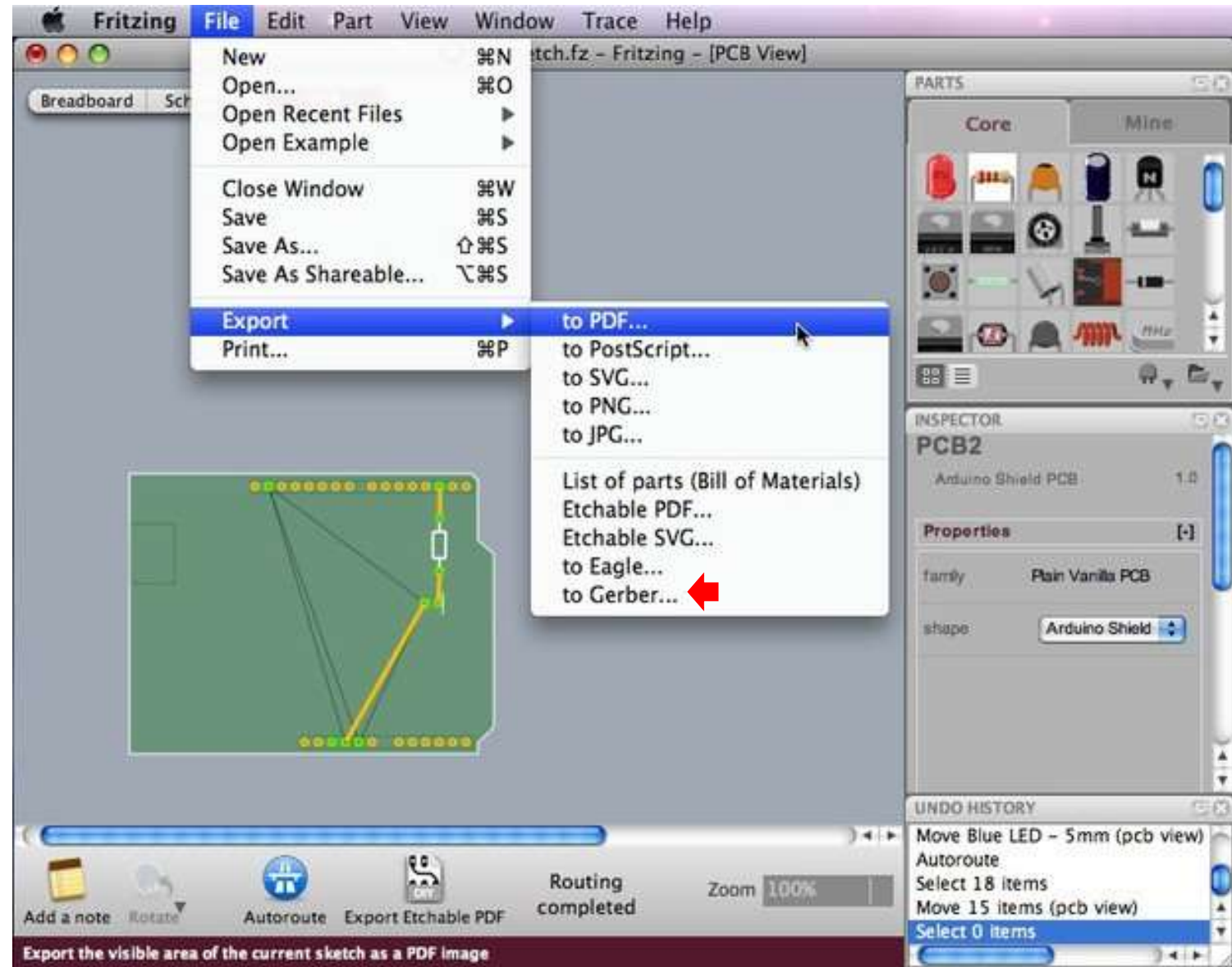

Esercitazione LAB2

- Realizzare circuito Fritzing (breadboard/schematico/PCB layout) per il sistema di testing meccanico progettato nell'esercitazione LAB1

3/05/2019 - Seminario CNR-IFC

- Neurobioingegneria
- Soluzioni ICT per health&care
- Tecnologie per il monitoraggio ambientale
- Ingegneria Cardiovascolare e Intelligenza Artificiale
- Biosensori
- Bioreattori e Biomateriali